

Pressostato KP 15A Danfoss

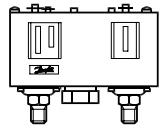

INSTRUCTIONS

KP 15A



060R9752

060R9752

The ammonia control can be used with R 717 (NH₃), CFC, HCFC and HFC refrigerants

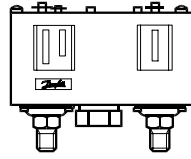

Ambient temperatures

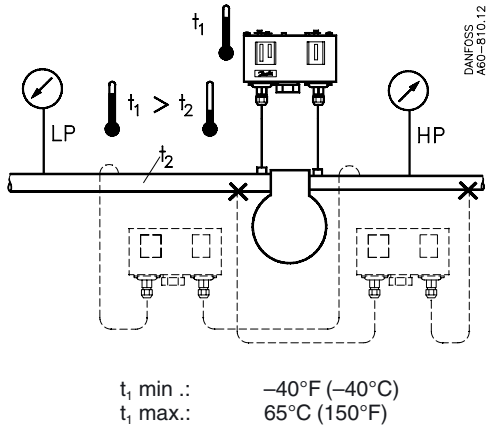

CAUTION: Do not mount the control in a position where dirt, sediment or oil will affect the operation of the control.

Test pressure (p_{TEST})

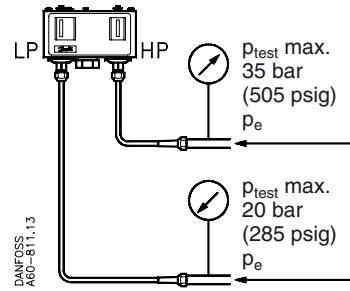

Connections

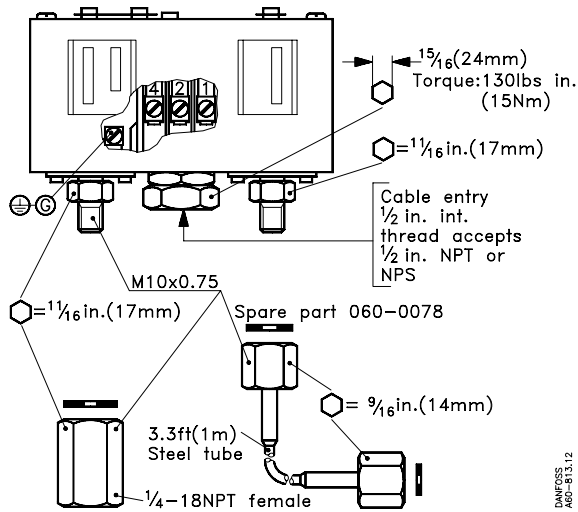

Cutting ring

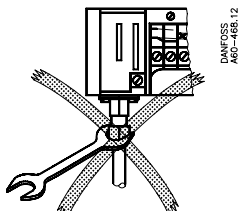
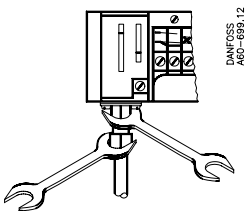
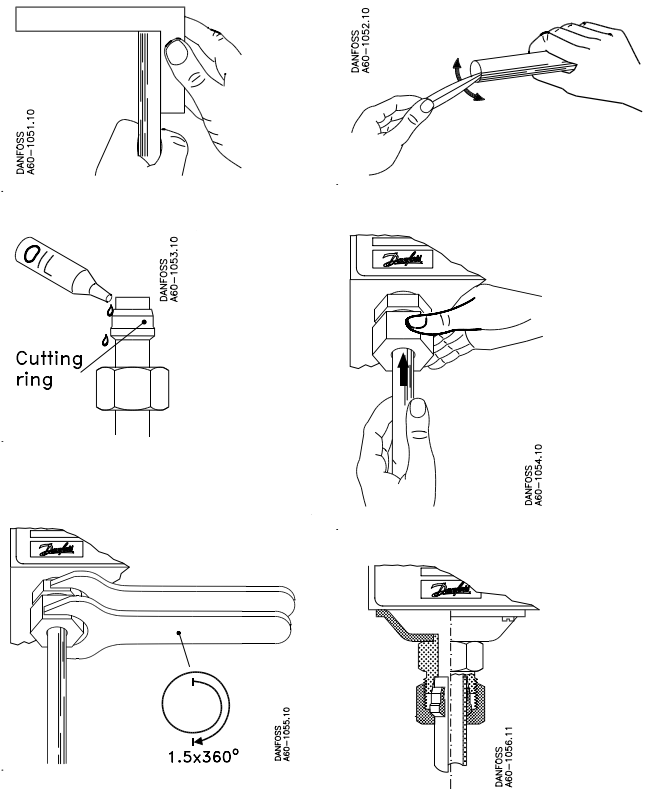

Enclosure

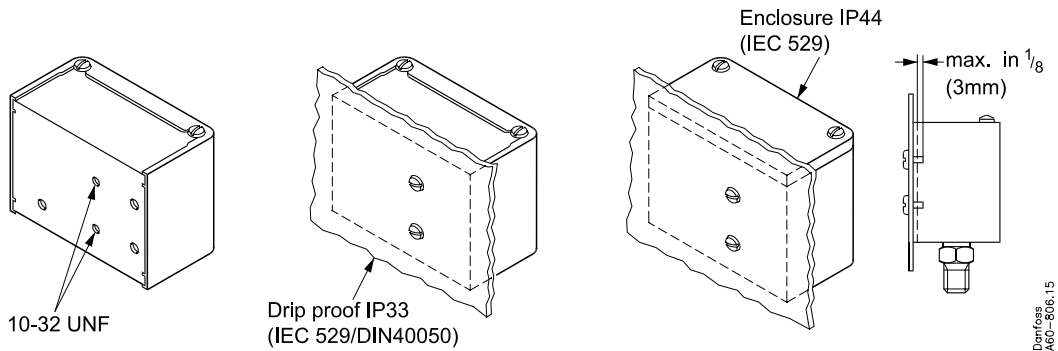

CAUTION: The mounting panel must be plane to avoid damage of control.

Wiring

CAUTION: Disconnect power supply before wiring connections are made to avoid possible electrical shock or damage to equipment.

All wiring should conform to the National Electrical Code and local regulations.

SPDT
Controls with low pressure (LP) signal

Controls with low pressure (LP) and high pressure (HP) signal

Contact load ratings

120 V a.c.	16 FLA, 96 LRA
240 V a.c.	8 FLA, 48 LRA
240 V d.c.	12 W pilot duty

See label inside cover

Terminal block

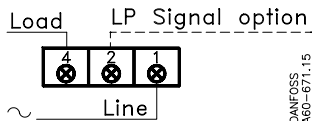

CAUTION: Use terminal screws furnished in the contact block.
Use tightening torque 20 lb. in (2.3 Nm).
Use copper wire only.

Low pressure (LP) side:
A-C close on LP rise
A-C open on LP drop

High pressure (HP) side:
A-C open on HP rise
A-C close on HP drop

LP signal option:
A-B close on LP drop

See label for current wiring inside cover

Terminal block

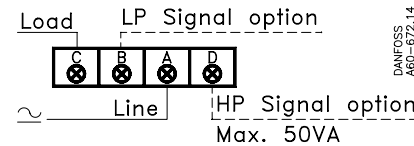

CAUTION: Use terminal screws furnished in the contact block.
Use tightening torque 20 lb. in (2.3 Nm).
Use copper wire only.

Low pressure (LP) side:
A-C close on LP rise
A-C open on LP drop

High pressure (HP) side:
A-C open on HP rise
A-C close on HP drop

LP signal option:
A-B close on LP drop

HP signal option:
A-D close on HP rise

Function

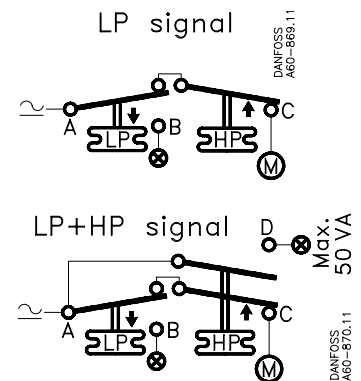

Note!

- (M) = Load
- (X) = Signal option
- ↕ = Bellows movement on pressure rise
- ↔ = Bellows movement on pressure drop

Electrical contacts/wiring test

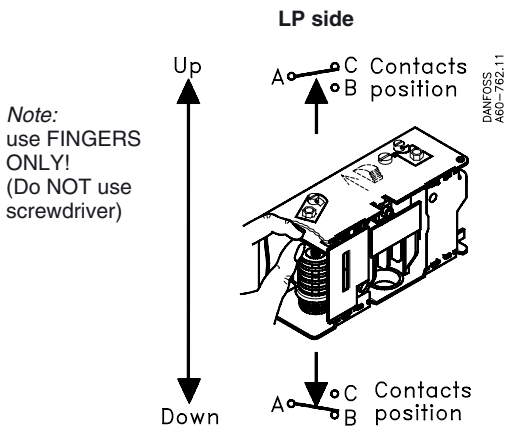

Note:
use FINGERS
ONLY!
(Do NOT use
screwdriver)

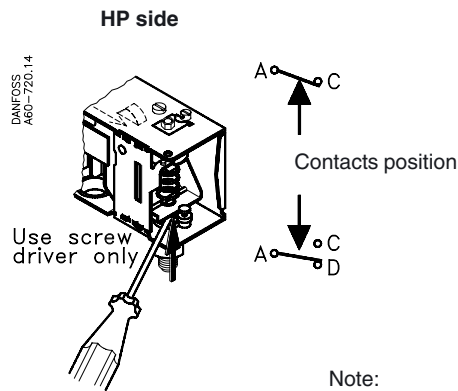

Note:
On controls with LP and/or HP man. reset,
push corresponding LP and/or HP man.
reset knob during tripping.

Manual reset

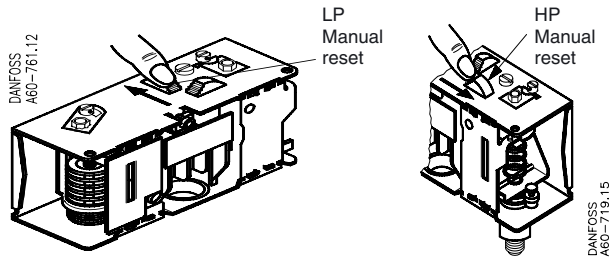

To resume control operation after safety
cut-out, push man. reset knob as indicated.

Note:
LP man. reset is possible only after system
pressure has risen above cut-in value.

HP man. reset is possible only after system
pressure has dropped below cut-out value.

Convertible reset

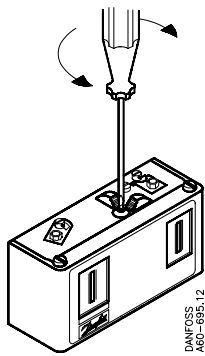

Turn plate to desired
reset configuration

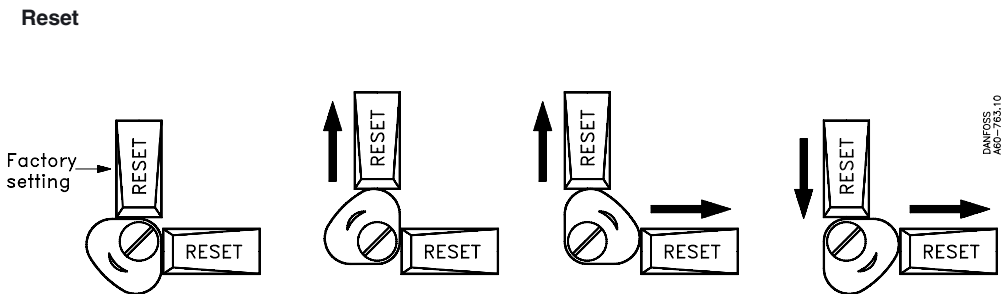

LP man.
HP-man.

LP-auto.
HP-man.

LP-auto.
HP-auto.

LP-man.
HP-auto.

Adjustment spindle(s) location

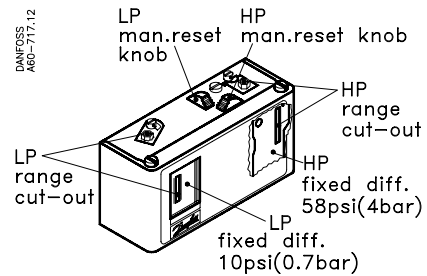
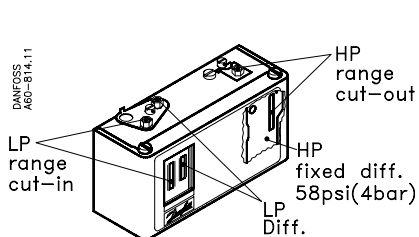

Setting

Low pressure (LP) side setting

KP 15A with LP auto. reset only

1. Adjust range spindle to desired CUT-IN value.
2. Adjust differential spindle to desired DIFFERENTIAL (DIFF.) value.

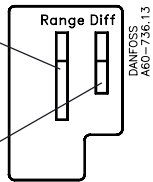

KP 15A with LP man. reset only
KP 15A with convertible LP auto./man. reset

1. Adjust range spindle to desired CUT-OUT value.
2. DIFFERENTIAL (DIFF.) is fixed. Value printed on scale plate.

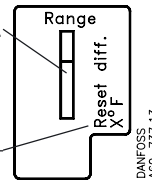

High pressure (HP) side setting

KP 15A with HP auto. or man. reset

1. Adjust range spindle to desired CUT-OUT value.
2. DIFFERENTIAL (DIFF.) is fixed. Value printed on scale plate.

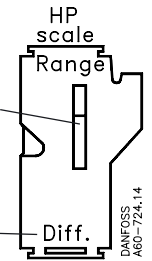

CUT-IN minus DIFFERENTIAL equals CUT-OUT

Example:
CUT-IN - DIFF. = CUT-OUT
30 psig - 10 psi = 20 psig
(2.1 bar) - (0.7 bar) = (1.4 bar)

CUT-IN equals CUT-OUT plus DIFFERENTIAL

Example:
CUT-OUT + DIFF. = CUT-IN
12 psig + 10 psi = 22 psig
(0.8 bar) + (0.7 bar) = (1.5 bar)

CUT-OUT minus DIFFERENTIAL equals CUT-IN

Example:
CUT-OUT - DIFF. = CUT-IN
203 psig - 58 psi = 145 psig
(14 bar) - (4 bar) = (10 bar)

Adjustment

LP range

Increase 360° CW \oplus } 10psi (0,7bar) /rev.
Decrease 360° CCW \ominus }

LP diff.

Decrease 360° CCW \ominus } 2psi (0,15bar) /rev.
Increase 360° CW \oplus }

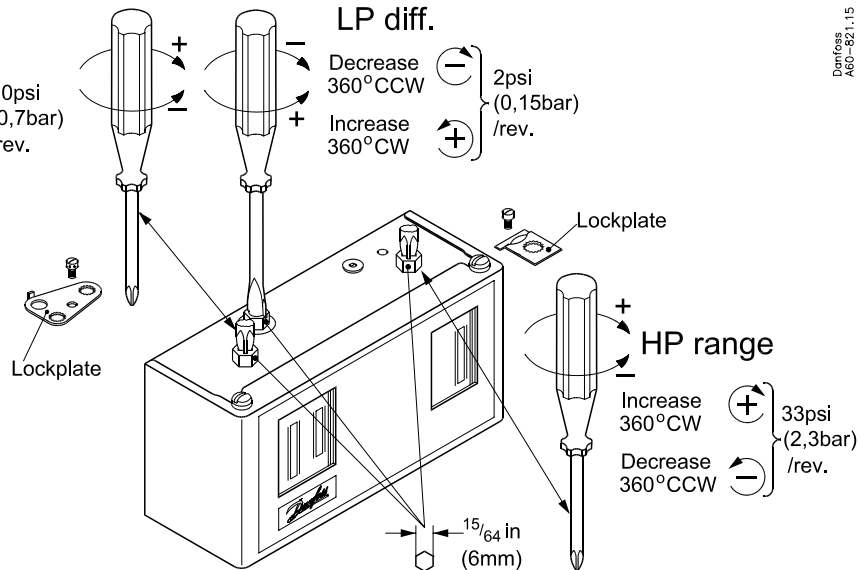

Note:
Remove lockplate before adjustment.
Replace lockplate after adjustment (if desired).